

SUOMEN VALKOISEN RUUSUN JA  
SUOMEN LEIJONAN RITARIKUNNAT

# A GUIDE TO THE ORDERS AND DECORATIONS OF FINLAND

THE ORDERS OF THE WHITE ROSE OF FINLAND  
AND THE LION OF FINLAND





SUOMEN VALKOISEN RUUSUN JA  
SUOMEN LEIJONAN RITARIKUNNAT

A GUIDE  
TO THE ORDERS  
AND DECORATIONS  
OF FINLAND

THE ORDERS OF THE WHITE ROSE OF FINLAND  
AND THE LION OF FINLAND

Helsinki 2017

*Front cover: Grand Crosses of the Orders of the White Rose of Finland and the Lion of Finland*  
*Back cover: Adapted from E.F. Wrede, Finlands utmärkelsetecken (Helsingfors 1946)*

© Suomen Valkoisen Ruusun ja Suomen Leijonan ritarikunnat 2017

Layout: Edita Publishing Ltd

Illustrations and design: Laura Noponen

Photographs: The Orders of the White Rose of Finland  
and the Lion of Finland, unless otherwise indicated

Translation: Foreign Languages Unit, Prime Minister's Office

ISBN 978-951-37-7191-1

Printed by Bookwell Ltd

Porvoo 2017



*Sauli Niinistö, President of the Republic of Finland and Grand Master of the Orders of the White Rose of Finland and the Lion of Finland, and Mrs Jenni Haukio.  
Photograph: Office of the President of the Republic/Matti Porre*

# PREFACE

---

---

The statutes of the Order of the White Rose of Finland (FWR) were adopted on 16 May 1919. The decorations of the Order are conferred upon citizens who have distinguished themselves in the service of Finland. The Order of the Lion of Finland (FL) was founded by decree (747/1942) during the Second World War, and its decorations are awarded in recognition of outstanding civilian or military conduct. Foreign nationals may also be awarded FWR and FL decorations. The grounds for conferral are meritorious conduct for the good of Finland.

The President of the Republic of Finland serves as the Grand Master of the Orders and has the exclusive right to confer decorations. The Orders of the White Rose of Finland and the Lion of Finland have a joint Chapter, staff and Chancery.

Decorations conferred upon Finnish citizens are awarded annually on Finland's Independence Day (6 December). On the Flag Day of the Finnish Defence Forces (4 June), decorations are conferred upon representatives of the defence administration and upon those in the service of the Finnish Defence Forces and the Finnish Border Guard.

A diploma is also given with each decoration. The case of issue contains not only the decoration conferred, but also a miniature and a designation.

In decorating members of the diplomatic corps and defence attachés and in awarding decorations during state visits, the principle of reciprocity is observed.

This guide contains information about the use and wearing of orders and decorations with different forms of attire, and sets out other important guidelines. It also presents the history of the conferral of decorations. The guide has been produced in three languages: English, Finnish and Swedish. It focuses on the fundamental elements of Finland's honours system and is intended for first-time recipients of decorations and for anyone requiring information about Finnish orders and decorations. Further information is available on the website of the Orders of the White Rose of Finland and the Lion of Finland: [www.ritarikunnat.fi](http://www.ritarikunnat.fi).

The guide aims to broaden and deepen awareness of the history of the honours system and the traditions of wearing decorations. The Finnish honours system follows established practices and procedures and is very broad based, awarding citizens from all walks of life. The decorations of the Orders of the White Rose of Finland and the Lion of Finland, together with those of the Order of the Cross of Liberty, have a key part to play within the state honours system. Being acknowledged and recognised for exceptional merits, achievements or service is still important in all fields and at all levels in Finnish society.

The wearing of decorations also enhances the status of ceremonial and other special events and adds a further dimension to such occasions. The dignity and solemnity of an occasion can be underlined by the dress code: white tie (full evening dress), black tie (dinner jacket) or dark suit. Note that Finnish tradition requires a dark suit and not a lounge suit. In the case of military and other uniforms, decorations may be worn with mess dress (ceremonial evening), mess dress (non-ceremonial evening) or full dress uniform.

With Finland's independence centenary celebrations and subsequent anniversaries in mind during the period 2017–2019, the Orders of the White Rose of Finland and the Lion of Finland have renewed their principal guidelines on the wearing of insignia. This revised and updated guide will be issued to all Finnish and foreign citizens receiving FWR and FL decorations.

The Finnish honours system continues to serve its purpose well and is an invaluable expression of Finland's identity as a state. Our honours system is also held in high regard internationally. The significance of the Orders extends beyond ceremonial and other special occasions, reaching into everyday life.

Our work is dedicated to the service of our country, or, in the words of the motto: *For the Good of the Fatherland!*

Helsinki, 2017, the centenary year of Finland's independence  
Rear Admiral Antero Karumaa  
Secretary of the Orders of the White Rose of Finland  
and the Lion of Finland

# THE ORDERS OF THE WHITE ROSE OF FINLAND OF FINLAND AND THE LION OF FINLAND: FACTS AND FIGURES

---



## THE ORDER OF THE WHITE ROSE OF FINLAND (FOUNDED 1919)

*General of the Cavalry, later Marshal of Finland, Baron Gustaf Mannerheim established the Order of the White Rose of Finland in 1919 in his capacity as Regent. Here Regent G. Mannerheim is wearing the Grand Cross with Collar of the Order of the White Rose of Finland.*

## THE ORDER OF THE LION OF FINLAND (FOUNDED 1942)

*The Order of the Lion of Finland celebrates its 75th anniversary in 2017. It was founded during the Second World War, in 1942. The illustration shows the Grand Cross of the Order of the Lion of Finland, as drawn by the insignia's designer, Oskar Pihl.*



## DIAMONDS

*Decorations of the Order of the White Rose of Finland may also be conferred with diamonds. Pictured is Finnish composer Jean Sibelius on his birthday in 1950, seated by a table on which his Grand Cross star with diamonds is displayed in its open case. The Grand Cross star with diamonds is also illustrated.*





TOTAL NUMBER OF DECORATIONS CONFERRED TO FINNISH NATIONALS 1919–2017\*

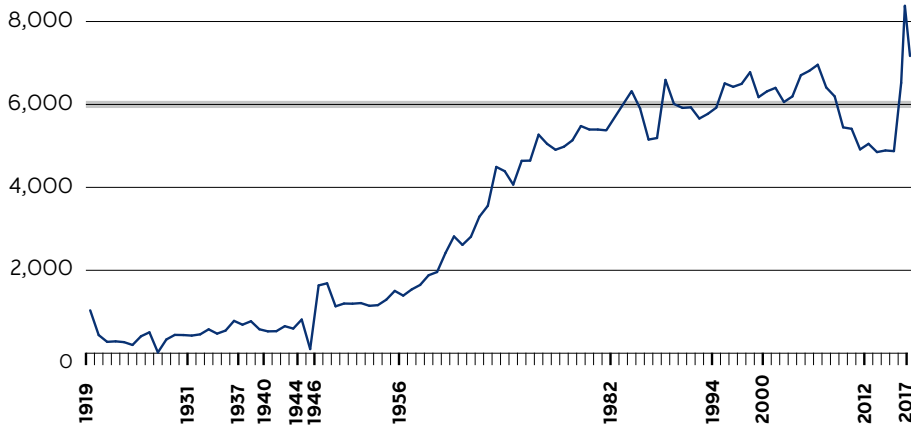

\* ESTIMATED NUMBER OF DECORATIONS 2017: 5,666

*By 2016, a total of 337,881 decorations of the Orders of the White Rose of Finland (FWR) and the Lion of Finland (FL) had been conferred to Finnish nationals since the founding of the first of these Orders in 1919.*

DECORATIONS CONFERRED TO FINNISH NATIONALS IN 2016

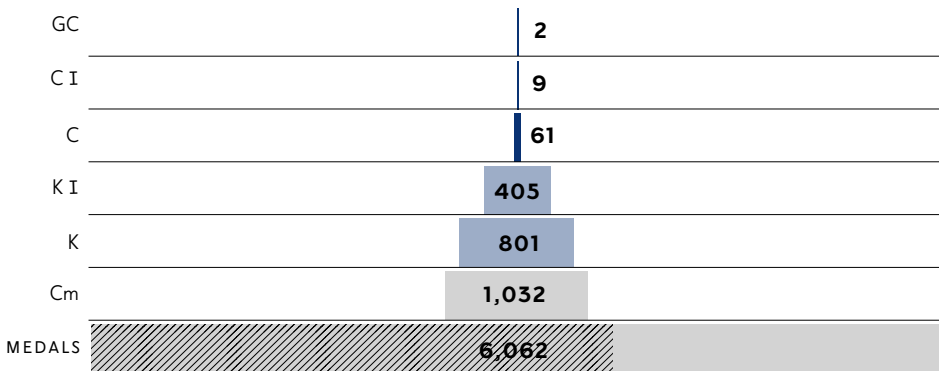

- TOTAL 8,382**
- Highest classes of the Orders 1%
  - Knights of the Orders 14%
  - Crosses of Merit and Medals of the Orders 85%
  - ▨ 3,616 Medals to war veterans (60%)

*In 2016, the number of FWR and FL decorations awarded was 8,382. Only 1% of these were in the highest classes (Grand Crosses and Commanders). Out of the total number of decorations conferred, 85% were Crosses of Merit and Medals.*

# DECORATIONS OF THE ORDERS OF THE WHITE ROSE OF FINLAND AND THE LION OF FINLAND

---

---

## Full-size decorations

THE FIVE SENIOR DECORATION CLASSES, CROSS OF MERIT AND THREE MEDAL CLASSES OF THE ORDER OF THE WHITE ROSE OF FINLAND (FWR) ARE AS FOLLOWS:

- Grand Cross (FWR GC)
- Commander First Class (FWR C I)
- Commander (FWR C)
  
- Knight First Class (FWR K I)
- Knight (FWR K)
  
- Cross of Merit (FWR Cm)
- Medal First Class with Gold Cross (FWR M I gold)
- Medal First Class (FWR M I)
- Medal (FWR M)

THE FIVE SENIOR DECORATION CLASSES, PRO FINLANDIA MEDAL AND CROSS OF MERIT OF THE ORDER OF THE LION OF FINLAND (FL) ARE AS FOLLOWS:

- Grand Cross (FL GC)
- Commander First Class (FL C I)
- Commander (FL C)
  
- Pro Finlandia Medal (FL PF)
  
- Knight First Class (FL K I)
- Knight (FL K)
  
- Cross of Merit (FL Cm)

The cross size and ribbon width are at their greatest for the Grand Cross and are reduced for the Commander First Class and Commander. The ribbon width for Knights is narrower still, but remains at this width for all decorations down to Medals.

Once the ribbon is sewn in place, the total height of a full-size decoration with its ribbon should be about 10 cm. The corresponding height of miniatures should be about 5 cm (see p. 20).

As a special mark of honour, a decoration may be conferred with a collar (for FWR GC), diamonds or clasp. The clasps of the FL Knight First Class and Knight are in the shape of the Olympic Games symbol, in gold for the Knight First Class and in silver for the Knight (see p. 13). The Grand Master determines the nature and form of the clasps.

The FWR and FL decorations are conferred with swords only for meritorious military conduct in wartime.

## Miniatures

Besides the full-size decorations there are also reduced size editions. These small decorations, known as miniatures, are approximately 40 per cent of the size of the full-size decorations.

When FWR and FL decorations from Grand Cross to Knight are conferred, the case of issue containing the decoration also includes a miniature and a designation or ribbon bar (see below). Once the ribbon is sewn in place, the overall height of a miniature with its ribbon should be about 5 cm (see p. 20). Further information about the wearing of miniatures with different forms of attire is given on pages 21–23 and 25–27 and on the website of the Orders of the White Rose of Finland and the Lion of Finland, at [www.ritarikunnat.fi](http://www.ritarikunnat.fi).

## Designations and ribbon bars

If neither the full-size decoration nor the miniature is worn, a designation may instead be worn on the left lapel or, for ladies, at the corresponding point on their garment. Depending on the class, the designation can be a rosette, a ribbon bow or a narrow ribbon. A demi-barrette under the rosette indicates the class, from Grand Cross to Commander:

- Grand Cross
- Commander First Class
- Commander
- gold
- gold-silver
- silver

Knight First Class is indicated by a rosette. The designation for a Knight is a ribbon bow. For the Cross of Merit and the Medal, the designation is a 3 mm wide ribbon extending over the outer edge of the left lapel. The designation may also be worn with a black tie (dinner jacket) on occasions when miniatures are not worn. Only one designation may be worn at a time.

Ribbon bars are worn on the uniforms of the Finnish Defence Forces, the police, rescue departments and other similar organisations. They are attached to a brooch-bar that is 10 mm high and positioned so that its lower edge is 5 mm above the left breast pocket. The edges of the ribbons must not overlap. The centre line of the ribbon bars should be at the centre line of the breast pocket. No more than four ribbon bars side by side may be sewn on to the brooch-bar.



## THE ORDER OF THE WHITE ROSE OF FINLAND

### GRAND CROSS WITH COLLAR OF THE ORDER OF THE WHITE ROSE OF FINLAND



FWR GC collar

### GRAND CROSS OF THE ORDER OF THE WHITE ROSE OF FINLAND



FWR GC (for ladies)



FWR GC (for gentlemen)

### COMMANDER FIRST CLASS OF THE ORDER OF THE WHITE ROSE OF FINLAND



FWRC I (for ladies)



FWRC I (for gentlemen)

## COMMANDER OF THE ORDER OF THE WHITE ROSE OF FINLAND



FWR C (for ladies)



FWR C (for gentlemen)

## KNIGHT FIRST CLASS OF THE ORDER OF THE WHITE ROSE OF FINLAND KNIGHT OF THE ORDER OF THE WHITE ROSE OF FINLAND



FWR K I



FWR K

## CROSS OF MERIT OF THE ORDER OF THE WHITE ROSE OF FINLAND MEDALS OF THE ORDER OF THE WHITE ROSE OF FINLAND



FWR Cm



FWR M I gold



FWR M I



FWR M

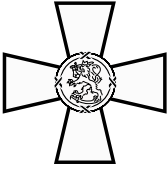

THE ORDER OF THE LION OF FINLAND

GRAND CROSS OF THE ORDER  
OF THE LION OF FINLAND



FL GC (for ladies)



FL GC (for gentlemen)



COMMANDER FIRST CLASS OF THE ORDER OF THE LION OF FINLAND



FL C I (for ladies)



FL C I (for gentlemen)



## COMMANDER OF THE ORDER OF THE LION OF FINLAND



FL C (for ladies)



FL C (for gentlemen)

## PRO FINLANDIA MEDAL OF THE ORDER OF THE LION OF FINLAND KNIGHT FIRST CLASS OF THE ORDER OF THE LION OF FINLAND



FL PF



FL K I clasp



FL K I

## KNIGHT OF THE ORDER OF THE LION OF FINLAND



FL K clasp



FL K

## CROSS OF MERIT OF THE ORDER OF THE LION OF FINLAND



FL Cm



# THE ORDER OF THE WHITE ROSE OF FINLAND



FWR GC



FWR C I



FWR C



FWR K I



FWR K

*Miniatures of the Order of the White Rose of Finland, from Grand Cross to Knight.*

*Designations and ribbon bars of the Order of the White Rose of Finland, from Grand Cross to Knight.*



FWR GC



FWR C I



FWR C



FWR K I



FWR K



FWR GC



FWR C I



FWR C



FWR K I



FWR K



THE ORDER OF THE LION OF FINLAND

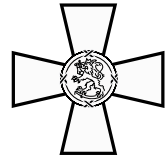

FL GC



FL C I



FL C



FL PF



FL K I



FL K

*Miniatures of the Order of the Lion of Finland, from Grand Cross to Knight.*

*Designations and ribbon bars of the Order of the Lion of Finland, from Grand Cross to Knight.*



FL GC



FL C I



FL C



FL PF



FL K I



FL K



FL GC



FL C I



FL C



FL PF



FL K I



FL K

# WEARING DECORATIONS WITH DIFFERENT FORMS OF ATTIRE

---

---

Guidelines on the wearing of Finnish decorations are laid out in a set of rules adopted on 1 June 1940 and in subsequent amendments to them. Decorations may be worn with all military and other uniforms (clergy, police, etc.) worn as formal dress.

## CIVILIAN ATTIRE WITH WHICH DECORATIONS MAY BE WORN

- white tie (full evening dress): either full-size decorations or miniatures
- dark suit: for gentlemen, only full-size decorations; ladies may wear either full-size decorations or miniatures
- national dress: for gentlemen, only full-size decorations; ladies may wear either full-size decorations or miniatures
- black tie (dinner jacket): miniatures only

The organiser of the occasion will specify the dress code and whether decorations are to be worn. The invitation might say, for example, ‘white tie (full evening dress) and decorations’ or ‘dark suit and decorations’. For ladies, decorations are worn as indicated in the dress code for the corresponding gentlemen’s attire. In the case of ladies’ dress that corresponds to a dark suit, miniatures may be worn instead.

Decorations worn with a ribbon on the chest are attached on the left side with the top edge of the ribbons a little below the buttonhole on the lapel (see pp. 20 and 24). If two or more decorations are worn, they should be sewn together in a row on the brooch-bar, though there should be no more than four decorations side by side if they do not overlap. If more than four, the ribbons may overlap such that the ribbon of a more senior decoration overlays that of a less senior one. The lower edges of the decorations must all be at the same level. This applies both to full-size decorations and miniatures. If a breast pocket handkerchief or pocket square is used, the decorations must not cover it. Breast pocket handkerchiefs and pocket squares are not used with full-size decorations. The total height of a full-size decoration with its ribbon should be about 10 cm. The corresponding height of miniatures is about 5 cm (see pp. 20–21 and 24–25).

## Wearing of full-size decorations

With a dark suit, full dress uniform or male national dress, only full-size decorations are worn.

With a white tie (full evening dress) or formal clerical attire, either full-size decorations or miniatures may be worn. With mess dress (ceremonial evening), either full-size decorations (with certain restrictions) or miniatures may be worn.

At ceremonial and other special occasions held outdoors, full-size decorations may be worn on an overcoat at chest height.

### FULL-SIZE DECORATIONS OF DIFFERENT CLASSES ARE WORN AS FOLLOWS:

- **Grand Cross:** the cross is worn on a sash from the right shoulder to the left hip (but on a neck ribbon for members of the clergy), and the star is worn on the left side of the chest. The length of the sash is adjusted according to the lower edge of the front of the tailcoat such that the bow is just below this lower edge (see p. 21). The sash for ladies is narrower than the gentlemen's sash. Ladies may wear a brooch or similar to keep the sash in place (see p. 22). The sash bow must be positioned just below the waist. The star should be attached on the left just below the position of decorations worn on the chest.
- **Commander First Class:** the cross is worn on a neck ribbon, and the star is worn as stated above. The ribbon is tied around the collar in such a way that the suspension ring is just below the bow tie (see pp. 21, 25 and 29). Ladies should wear the cross on a ribbon bow on the left side below the shoulder and above the position of other decorations worn on the chest (see pp. 22 and 25).
- **Commander:** the cross is worn on a neck ribbon. The ribbon is tied around the collar in such a way that the suspension ring is just below the bow tie (see pp. 21 and 25). Ladies should wear the cross on a ribbon bow on the left side below the shoulder and above the position of other decorations worn on the chest (see pp. 22 and 25).
- **Knight First Class, Knight, Cross of Merit and Medal:** the decoration, suspended from a ribbon, is worn on the left side of the chest (see e.g. pp. 21 and 25).

## Wearing of miniatures

Only miniatures may be worn with a black tie (dinner jacket) or mess dress (non-ceremonial evening). Miniatures may also be worn with a white tie (full evening dress), formal clerical attire or mess dress (ceremonial evening) on all occasions at which the wearing of decorations is required.

Ladies may wear miniatures on all occasions at which decorations are to be worn, including with dress corresponding to a dark suit and with national dress.

## Special cases

On official occasions attended by the President of the Republic of Finland or a visiting head of state, the sash of the Grand Cross is worn over the waistcoat, and official decorations may be worn on the chest; no more than two neck badges and four stars may be worn (see pp. 21 and 28).

The Insignia of Merit for Public Service (for 30 years' service) is worn above the position of decorations worn on the chest.

Decorations are not worn with a lounge suit.



*Oskar Pihl's drawings of FWR and FL decorations with swords given for meritorious military conduct in wartime.*

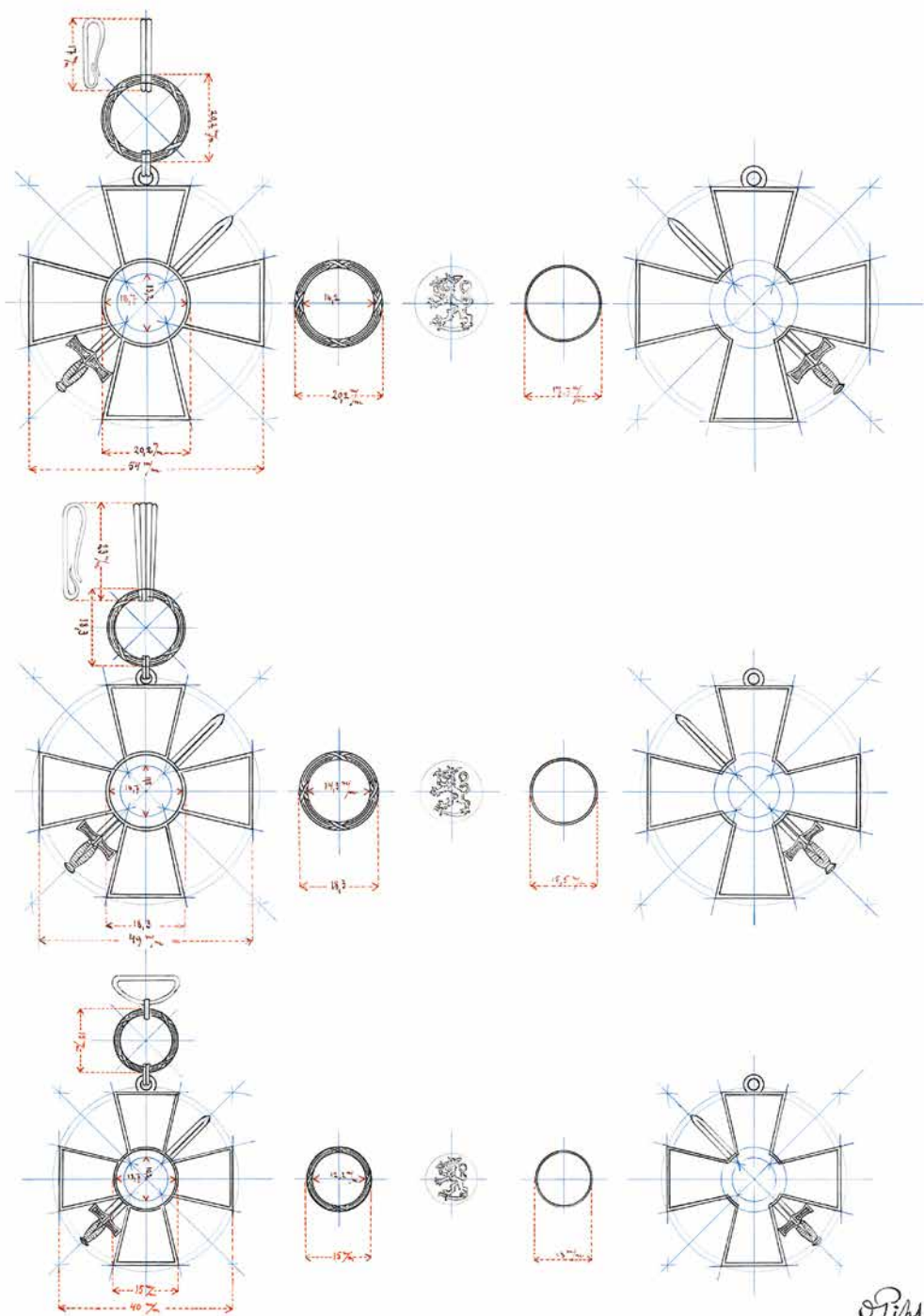

Oskar Pihl's dimensional drawings for the designs of the Order of the Lion of Finland.

# WHITE TIE (FULL EVENING DRESS)

---

---

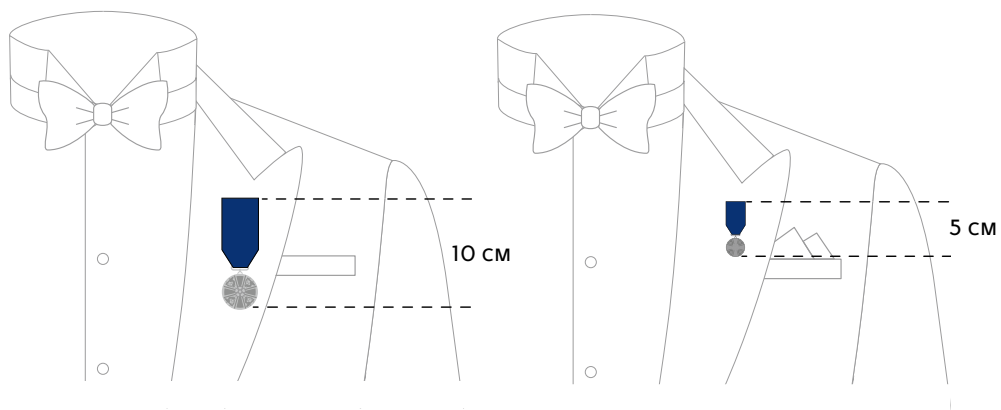

*The position of full-size decorations and miniatures when worn with a white tie (full evening dress).*

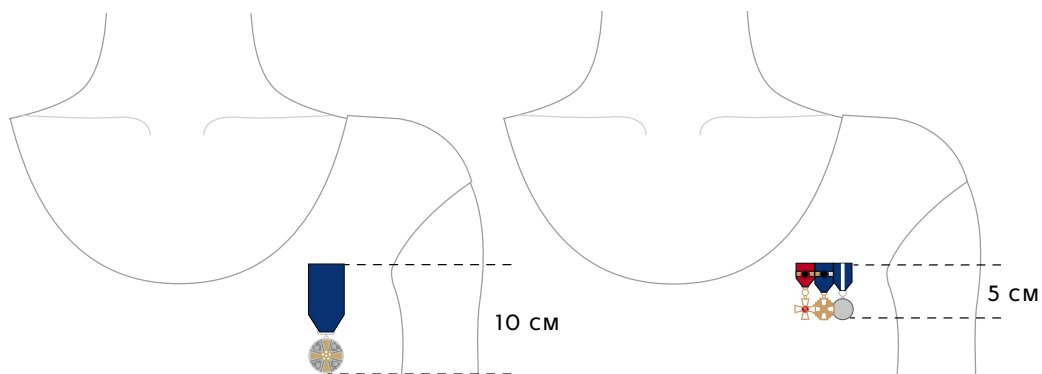

*Ladies' decorations should be placed in positions corresponding to those of gentlemen's decorations.*

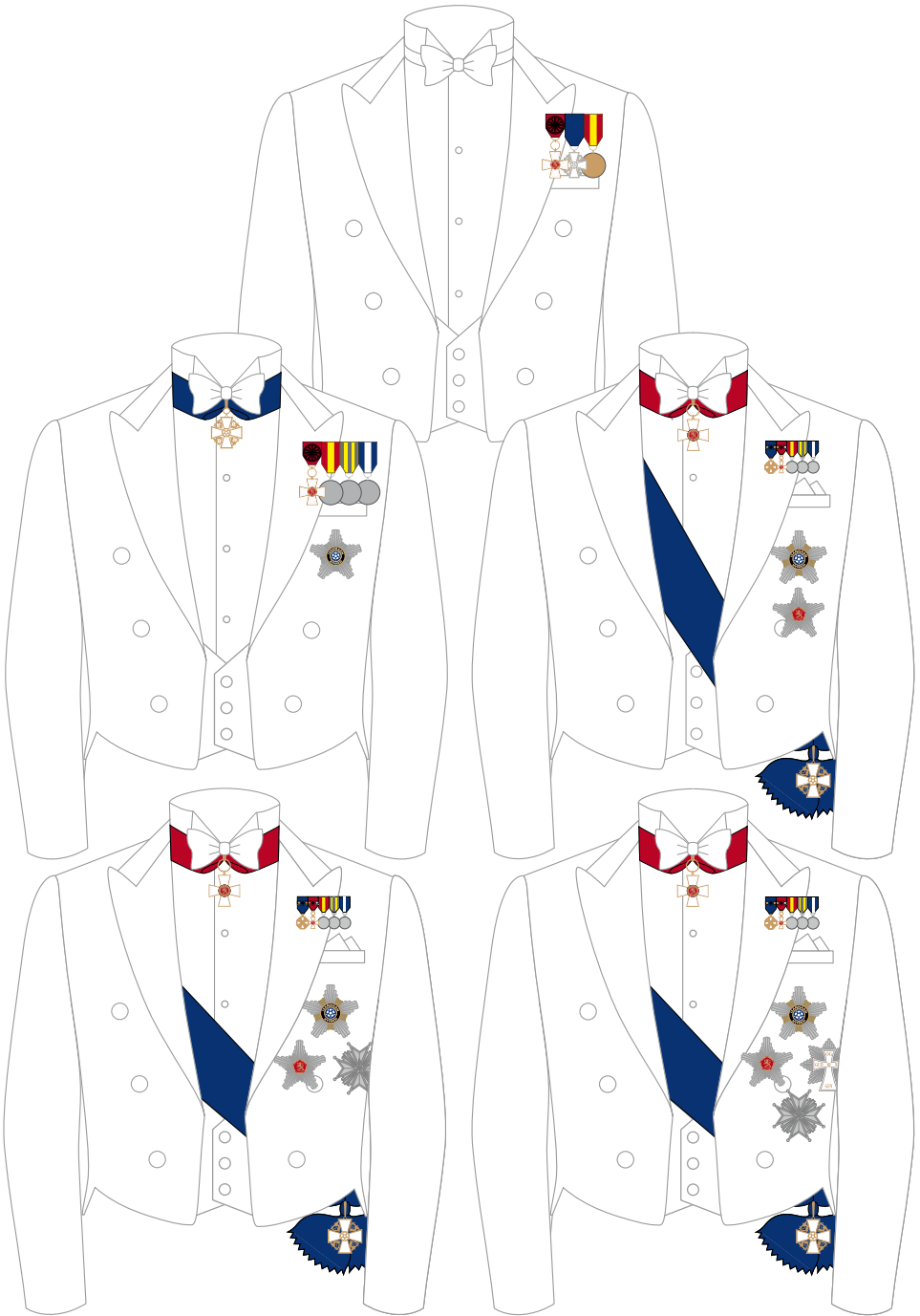

*Positioning of full-size decorations and miniatures worn on the chest and the Grand Cross, Commander First Class and Commander insignia, when worn with a white tie (full evening dress). The sash for a Grand Cross may be worn either over the shoulder or, alternatively, shortened and fastened with buttons to the waistcoat (see p. 28).*

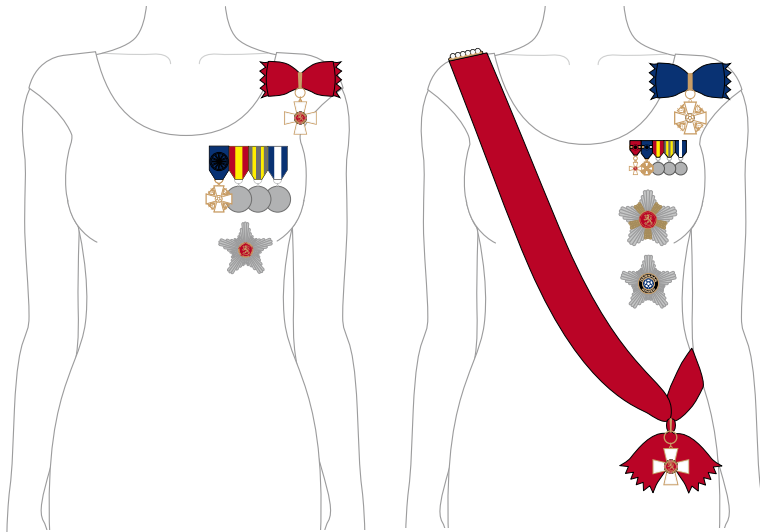

*Positioning of full-size decorations and miniatures and the Grand Cross, Commander First Class and Commander insignia, when worn with a full-length evening dress. Ladies may use a brooch or similar to secure the Grand Cross sash in place.*



# BLACK TIE (DINNER JACKET)

---

---

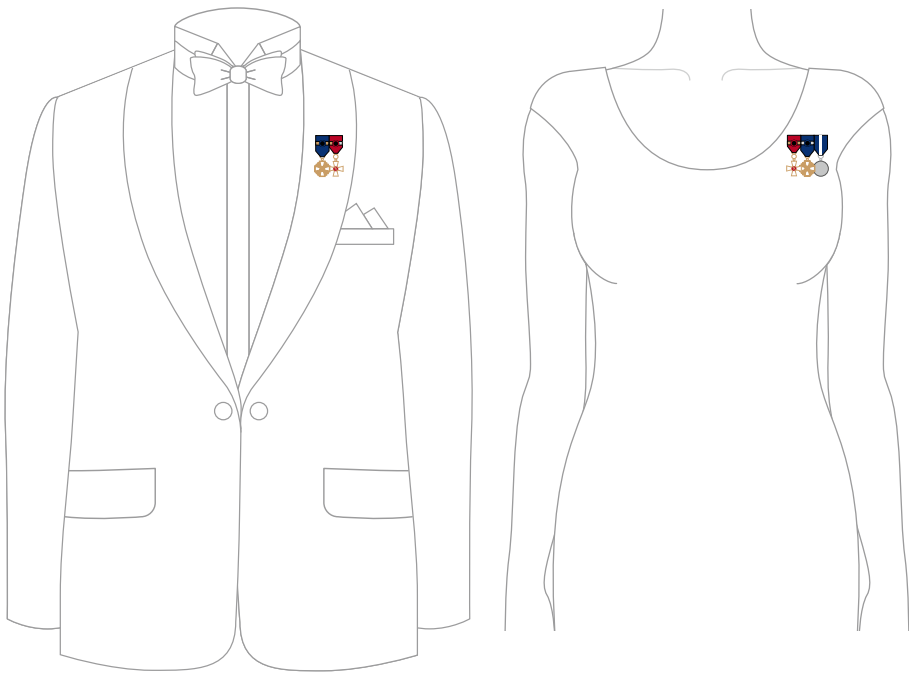

*Positioning of miniatures with black tie (dinner jacket) and with corresponding ladies' attire.*

# DARK SUIT

---

---

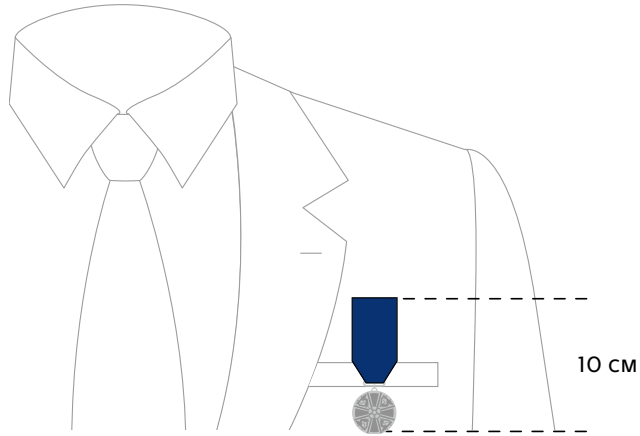

*Overall height and positioning of decorations when worn with a dark suit. It is not the breast pocket but the design of the suit that determines the positioning of decorations.*

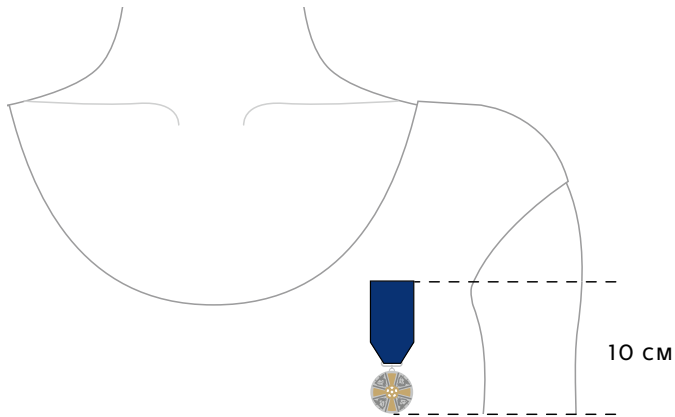

*Overall height and positioning of decorations with ladies' attire.*

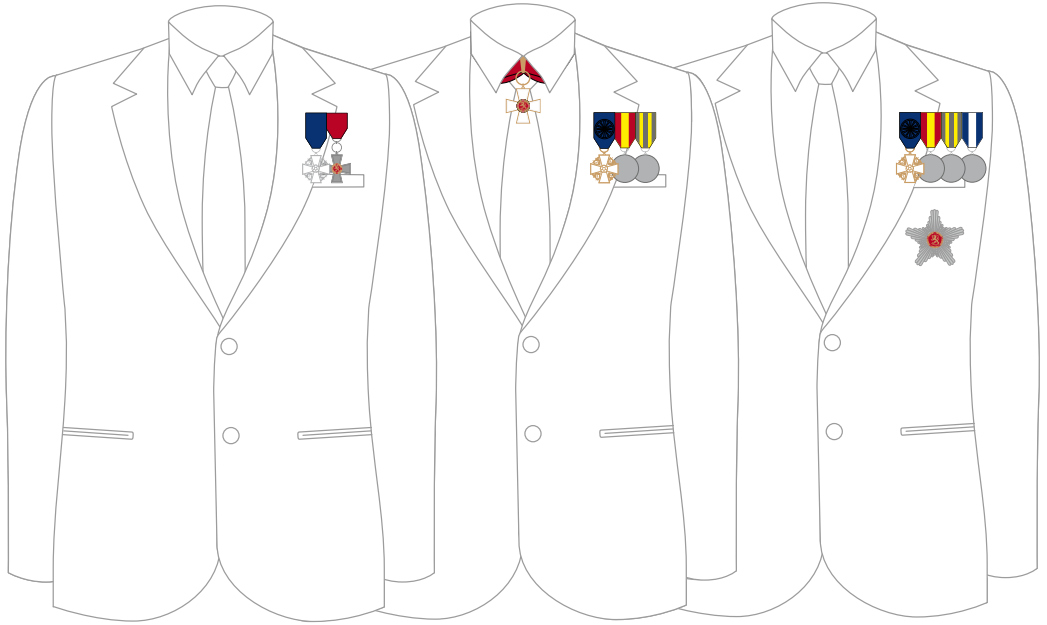

*Examples of the wearing of decorations with a dark suit, from Knight to Commander First Class. See also p. 29.*

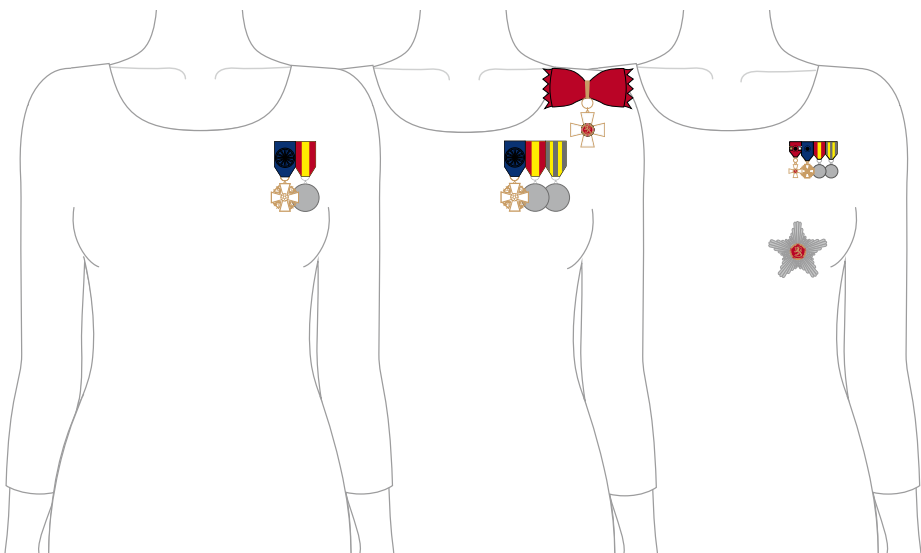

*Ladies' decorations are worn in a corresponding manner to those of gentlemen, but ladies may wear miniatures with attire that corresponds to a dark suit.*

# MILITARY AND OTHER UNIFORMS

---

---

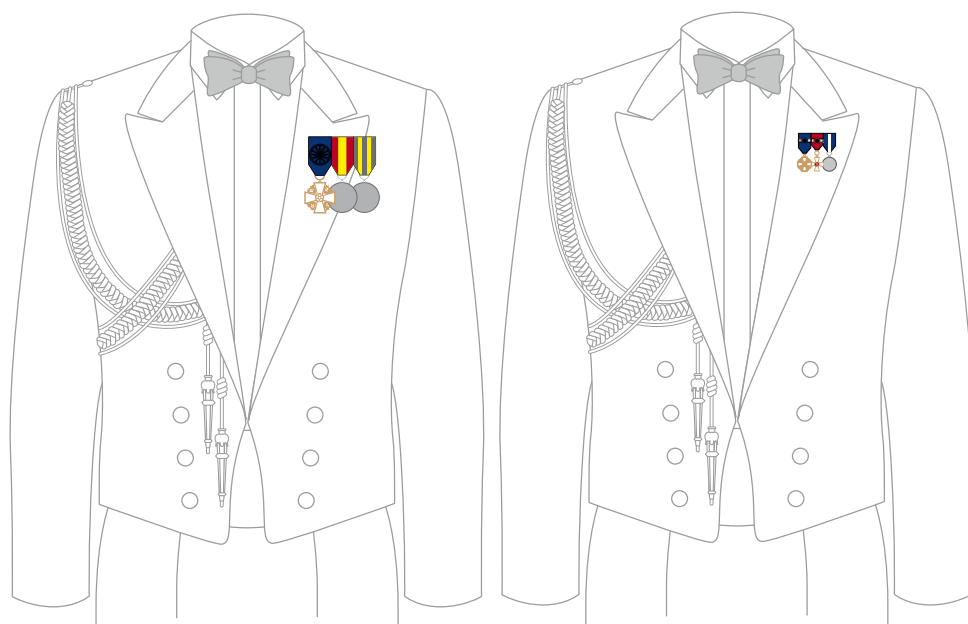

*With mess dress (ceremonial evening), either full-size decorations or miniatures may be worn.*

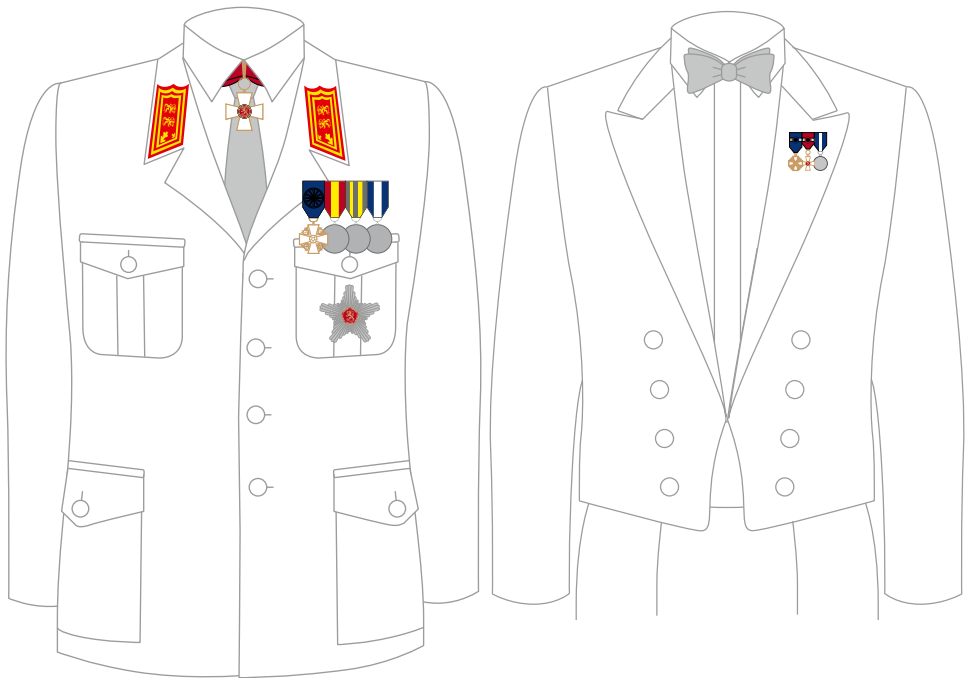

*Full-size decorations are worn with full dress uniform,  
and miniatures are worn with mess dress (non-ceremonial evening).*

# SPECIAL CASES

---

---

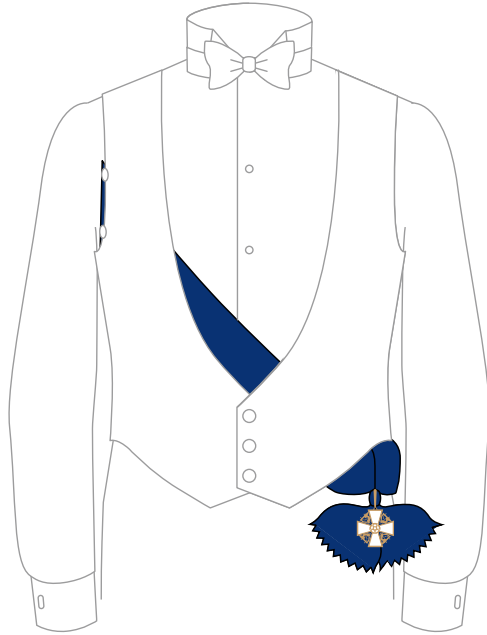

*The Grand Cross sash is worn under the waistcoat when the President of the Republic of Finland is not present; when the President is present, the sash is worn over the waistcoat (see p. 21).*

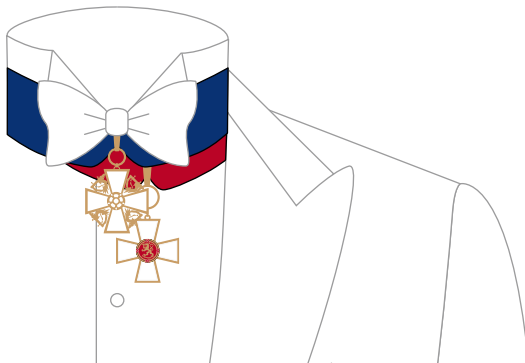

*If wearing two neck badges, the more senior of the two is worn above the other.*

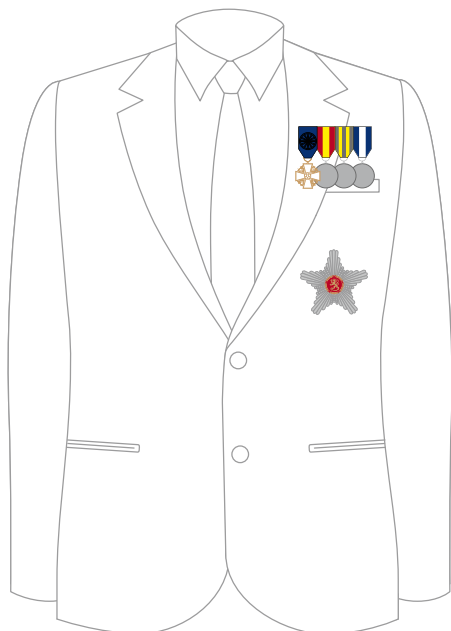

*When wearing a Commander First Class with a dark suit or with corresponding ladies' attire, only the Commander First Class star is worn.*

## DESIGNATIONS

---

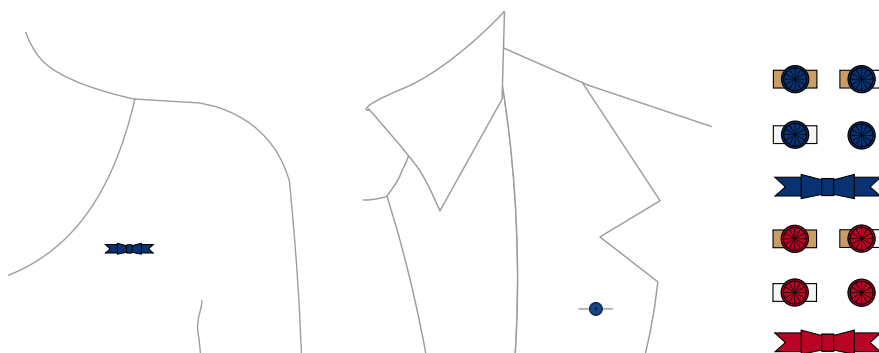

*Designations (the most common of which are shown on the right) are worn in the buttonhole of the lapel, and in the corresponding position on ladies' attire.*

## ON THE HISTORY OF THE ORDERS

*The decorations of Finland's three Orders are awarded on a comprehensive and wide-ranging basis to citizens who have distinguished themselves in services to the country in different fields.*

*While the orders of knighthood trace their origins back to the Middle Ages, today's orders of merit, which are merit-based and with multiple categories, developed gradually from the end of the seventeenth century.*

---

---

### General history of the orders of knighthood

The simple cloth crosses of the religious orders of knighthood, originally worn on cloaks at the time of the Crusades, served more as a badge of membership than as a decoration. There were also monarchical orders of knighthood established from the early fourteenth century onwards. Their principal insignia were typically jewel-like medallions. From the late sixteenth century, however, the eight-pointed, white Maltese cross used by the Knights of St John became commonly used as a symbol by monarchical orders of knighthood.

Deviating from these single-class monarchical orders, which were retained up to the end of the seventeenth century, modern orders of merit adopted the hierarchical structure used by the religious orders of knighthood and also the names of certain offices (e.g. Grand Master) and classes (e.g. Commander). However, the idea behind the insignia of the religious orders of knighthood was almost completely the reverse of the underlying principle in today's orders of merit. The precious metal and enamel crosses of today's orders of merit are primarily decorations recognising the bearer's merits, rather than indications of the membership of an order. The closer we get to the present day, the weaker the 'membership' nature of the orders, especially the orders of merit.



## Orders of merit

The clearest turning point in the early development of the orders as a modern institution was the creation in 1693 of the first multi-class order of military merit, the French Order of Saint Louis. The number of holders of the two highest classes of the Order – Commander Grand Cross and Commander – was restricted, but any Roman Catholic officer (even a non-noble) who fulfilled the criteria could be appointed a Knight of the Order. France also led the tendency to expand the membership of the orders by accepting members from the arts, science and commerce. With orders of knighthood being key symbols of the sovereignty of rulers, a common motivation for establishing new orders of knighthood was the management of international relations and demands for the diplomatic exchange of decorations.

In the eighteenth century, the importance of discharging duties with distinction and displaying courage grew within the orders, as did secularisation (though at a slow pace). Decorations of the Military Order of Maria Theresa, established in Austria in 1757, were awarded on the basis of eyewitness evidence to officers distinguishing themselves in acts of valour, irrespective of their social background and religious conviction. This completely secular order was one of the main prototypes for today's orders of merit. Orders of merit in the republics of today that honour civilians quite extensively too can be traced back primarily to the French Legion of Honour, founded by Napoleon in 1802. As Napoleon put it, the same decoration could, for the first time, equally be awarded to an illiterate soldier as to an intellectual.



*A Knight's Cross of the Order of Saint Louis of France. This type of ribbon bow, which was originally an emblem indicating that the knight is receiving the pension of the Order, later became the round rosette used in many orders to indicate an officer class or Knight First Class.*

## Swedish and Russian Orders

Modelled on the French Orders of the Holy Ghost, Saint Louis and Saint Michael, the single-class Order of the Seraphim was established in Sweden in 1748, along with the following, originally two-class, orders: the Order of the Sword, awarded for military merit, and the Order of the Polar Star, awarded principally for civic merits. Sweden's fourth order, the Order of Vasa, was founded in 1772 as a three-class order. At the same time, a third class was added to the Orders of the Sword and the Polar Star.

The Order of Vasa was always a free order, the decorations of which were awarded to, for example, representatives of commerce, agriculture and the arts, irrespective of birth or social status. In 1788, a special class, Knight Grand Cross, was established in the Order of the Sword for meritorious military conduct in wartime and was subsequently divided into two classes. This special class served as the model for the Finnish Mannerheim Cross, established in 1940. The wearing of Swedish decorations continued in the Grand Duchy of Finland after Sweden ceded Finland to Russia in 1809.

With Finland then an autonomous Grand Duchy of the Russia Empire, Russian decorations were duly awarded to Finns distinguishing themselves in services to the empire and the Grand Duchy. The founding of the Russian orders of knighthood began in the late seventeenth century and these developed into quite a complex system. There were eventually six Russian orders and the conferral of their decorations followed a hierarchical arrangement. These orders were the Orders of St Andrew, St Alexander Nevsky, the White Eagle, St Vladimir, St Anne and St Stanislaus. Outside the hierarchy were the Order of St Catherine, reserved for high-ranking ladies, and the Order of St George, the decorations of which were awarded to officers primarily for meritorious military conduct in wartime.



*A Knight's Cross of the Order of the Polar Star of Sweden.*



*The Russian Order of St George, 4th Class, awarded to Mannerheim. Photograph: Mannerheim Museum/Matias Uusikylä.*

Russian orders were highly regarded in Finland until the policy of russification began during the reign of Emperor Nicholas II. Since Finland gained her independence in 1917, the insignia of Russian imperial orders have scarcely been worn at all, and authorisation to wear them on Finnish military uniforms has never been officially granted. Mannerheim did, however, wear his Russian orders on his uniform from the 1920s until the 1940s, though naturally, given his standing, permission was not requested for this. Russian imperial orders were nevertheless mentioned in the State Calendar of Finland for as long as the Calendar included recipients of these decorations. The last such mention was in 1962.

## The Order of the Cross of Liberty

The Senate of Finland established the Crosses of Liberty and the Medals of Liberty on 4 March 1918 following proposals put forward by General of the Cavalry Mannerheim, Commander-in-Chief of the Finnish Military Forces. Mannerheim declared that the Cross of Liberty was established for the purpose of denoting and rewarding the heroic acts of soldiers on the battlefield and the self-sacrifice undertaken to lay the foundations for the liberty of Finland. As commanded by Mannerheim, and following his detailed guidelines, renowned Finnish artist Axel Gallen-Kallela designed the Crosses of Liberty and the Medals of Liberty. The highest classes of the Cross of Liberty incorporate a white cross similar to that of the Russian Order of St George. Gallen-Kallela superimposed on this a straight swastika,

which was declared to be “a symbol of the sun, life and freedom, a symbol of many nations”, and placed a heraldic rose at the centre. In the manner of the Russian Order of St George, the Cross of Liberty has four numbered classes, but it also has a Grand Cross in the Western European tradition. When, in January 1919, a new class was added to the Cross of Liberty, namely First Class with Star, the wearing of the Order’s four highest decorations corresponded to the classes of the Order of St George.

On 28 January 1919, having considered that the Cross of Liberty had fulfilled its purpose since Finland had gained her freedom and sovereign independence, Regent Mannerheim discontinued its conferral. However, the Cross of Liberty was reinstated during the Winter War, and a permanent Order of the Cross of Liberty was founded by decree on 16 December 1940. Mannerheim became the Grand Master of the Order for life. Since Mannerheim’s death, the Grand Mastership of the

Order of the Cross of Liberty has been vested in the Commander-in-Chief of the Finnish Defence Forces, that is to say the President of the Republic of Finland. On 18 August 1944, Mannerheim, as President of the Republic, issued a decree ratifying the statutes of the Order of the Cross of Liberty, and these are still in force today. The decorations of the Order of the Cross of Liberty are awarded for military merit and to civilians for distinguished actions in support of the Finnish Defence Forces. No Crosses of Liberty were conferred for peacetime merits in the period 1960–1988, apart from a few exceptional cases.



*Cross of Liberty Second Class with Swords, 1918.*



*'Honorable Order of the Rose of Finland'. Gallen-Kallela's sketch on the lid of a cigarette box, dated 2 February 1918, and accompanying notes. Photograph: Per Johan Lundsten.*

## The Orders of the White Rose of Finland and the Lion of Finland

Prior to Mannerheim assigning him the task of designing decorations, Gallen-Kallela had, of his own accord on 2 February 1918, sketched out on the lid of a box of cigarettes a design for a decoration he called the "Suomen Ruusun Kunniakunta" ("Honorable Order of the Rose of Finland").

When discontinuing the conferral of the Cross of Liberty in 1919, Mannerheim made the decision "to retain the white cross in somewhat altered form using the name White Rose of Finland". Gallen-Kallela was given the task of expeditiously designing the decorations for this new Order. The first decorations were required to be ready for Regent Mannerheim's visit to Stockholm, which began on 12 February 1919.

A white enamelled cross, familiar from the highest classes of the Cross of Liberty, became the basic form of cross for the Order of the White Rose of Finland (FWR), with the rose retained in the centre. Gallen-Kallela placed four lions of Finland issuant between the arms of the cross. The hue of the Order's lustrous dark blue ribbon was inspired by the ribbon of the Russian Order of the White Eagle. The blue ribbon and white cross of the Order of the White Rose of Finland provide heraldic reinforcement of the blue and white colours of the Finnish flag, which were adopted by statute in May 1918.

Mannerheim ratified the statutes of the Order of the White Rose of Finland on 16 May 1919. The Order celebrated this anniversary date, 16 May, until 1944, when the annual celebration date was changed to 6 December, Finland's Independence Day. The decorations of the Order of the White Rose of Finland are awarded to Finnish and foreign citizens distinguishing themselves in the service of Finland. The Grand Master of the Order is specified as Finland's head of state, who has the sole right to confer the Order's decorations. The motto of the Order is *For the Good of the Fatherland*.

“The decorations of the Order of the White Rose of Finland shall be conferred upon citizens distinguishing themselves in the service of their country.”

– G. MANNERHEIM, 16 MAY 1919

The classes confirmed in the FWR statutes were modelled on the Swedish Orders of the Sword and Vasa, but with the exception that not all Grand Crosses are conferred with a collar. The Order of the White Rose of Finland featured the following classes: Grand Cross, which could be awarded with a collar as a special mark of distinction; Commanders First and Second Class; and Knights First and Second Class. Silver and bronze Badges of Merit were also established, as were Medals First and Second Class. Since 1923, it has also been possible to award a Medal First Class with Gold Cross, bringing the number of Medal classes to three. The FWR decorations that were awarded to ladies were initially mainly the Badge of Merit and the Medals. The award of Knight has been conferred upon ladies more frequently since 1940, and the award of more senior classes a little after that.

In 1936, the Commander Second Class and Knight Second Class became Commander and Knight. At the same time, a round rosette was added to the ribbon of the Knight First Class. Gallen-Kallela had designed the stars in such a way that two of their five arms would point upwards. In conjunction with the other changes made in 1936, it was decided that the stars of the Order of the White Rose of Finland would instead be positioned so that just one of the arms is uppermost.

For meritorious military conduct in wartime, the FWR Grand Cross and Commanders and Knights have been conferred with swords.

As a special mark of honour, the FWR Grand Cross and Commander First Class have been conferred with diamonds. The Grand Cross with Diamonds was last awarded to composer Jean Sibelius, in 1950.

*Knight Second Class of the Order of the White Rose of Finland, 1919. The appearance of the Order's decorations has varied slightly over the years.*



*Gallen-Kallela's drawing of the Grand Cross of the Order of the White Rose of Finland.*



The Order of the Lion of Finland (FL) was established by decree of the President of the Republic Risto Ryti, issued on 11 September 1942. The Grand Master of the Order is "the President of the Republic of Finland, who alone has the right to confer the Order's decorations". The date of the Order's annual celebration was specified as 6 December. The introduction of the new Order

made it easier to match decorations more closely to the case and the merits in question. Certain shortcomings had become evident particularly in awarding foreign nationals, as previously there had been only one Grand Cross. The creation of a new Order also provided greater scope for differentiation in regard to other decoration classes. As with the Order of the White Rose of Finland, the Order of the Lion of Finland has a Grand Cross, but without a collar, and has a Commander First Class, Commander, Knight First Class, Knight and a Cross of Merit. In 1943, the Pro Finlandia Medal, awarded exclusively to artists and authors, was added to the Order. The FL decorations have also been conferred with swords for meritorious military conduct in wartime.

“The decorations of the Orders of the White Rose of Finland and the Lion of Finland were established to provide tangible recognition of distinguished action in the service of our country.”

– RISTO RYTI, 4 JANUARY 1944



The decree states: “The decorations of the Order of the Lion of Finland shall be awarded in recognition of outstanding civilian or military merit.” They may be conferred upon Finns and foreign nationals. The Orders of the White Rose of Finland and the Lion of Finland have a joint Chapter for deliberating on proposals for decoration conferrals, and the two Orders’ decorations are awarded for the same kinds of merits. This means that in practice they serve as a single Order. The order of precedence among the decoration classes of the two Orders

*Commander of the Order of the  
Lion of Finland with Swords.*



*Oskar Pihl's drawing of Commander First Class of the Order of the Lion of Finland.*



is such that an FL decoration is worn after an FWR decoration of the corresponding class.

Oskar Pihl, chief designer at A. Tillander, prepared the final drawings of the decorations for the Order of the Lion of Finland. As with the two older Finnish Orders, the basic form of the cross of the Order of the Lion of Finland is a white cross of the type of the Order of St George. The Lion of Finland was placed at the centre of the cross in a raised red roundel surrounded by a stylised wreath. The colour of the Order's ribbon is red, the same colour as the national coat of arms of Finland. The FL stars are slightly modified versions of the FWR stars.

When the Order of the White Rose of Finland was established in 1919, its decorations were conferred upon more than one thousand Finnish citizens. In the next two decades, however, the number of Finns receiving decorations was relatively small. The practice of awarding decorations on Independence Day began in 1936, when 270 Finnish citizens were honoured. The first time more than one thousand decorations were conferred was on Independence Day in 1948, and the two thousand mark was reached in 1963. Following that, the numbers grew rapidly, and on Independence Day in 1966 the total conferred was more than three thousand, while in 1971 the total exceeded four thousand and in 1982 five thousand. This growth was principally due to the award of more Medals of the Order of the White Rose of Finland, which meant that the conferral of honours had become more broadly based in society.

Only a small number of modifications have been made to the classes and appearance of the FWR and FL decorations since the Second World War. The swastikas on the collar of the FWR Grand Cross were replaced with fir crosses ('sprig crosses') in 1963. Since 1967, it has been possible to confer with a clasp the FL Knight First Class and Knight. The clasp awarded to gold medal winners in the Olympic Games and the Paralympic Games is in the shape of the Olympic symbol.

The FWR Medal Second Class was renamed Medal in 1984. In 1993, the FWR Badge of Merit, which from 1921 onwards had been awarded only to ladies, was

discontinued. It was replaced by the Cross of Merit of the Order of the White Rose of Finland, the appearance of which was the same as the Badge of Merit. In 1993, the Order's bronze Badge of Merit for meritorious military conduct in wartime was removed from the statutes of the Order; the award had never been conferred.

In 2008, the duty of foreign nationals to return decorations after the death of the recipient was also removed. There is therefore no requirement to return any decorations of the Orders of the White Rose of Finland and the Lion of Finland.

## Changing with the times

The wearing of decorations with civilian attire in Finland was officially restricted to white tie (full evening dress) until 1979. However, prior to 1979, full-size decorations had long been worn extensively with a dark suit and with the corresponding ladies' attire, especially at formal events for war veterans. In 1979, it was officially permitted to wear full-size decorations and one neck badge with a dark suit or national dress used as formal attire. Since 1990, holders of the Grand Cross and Commander First Class have, with the aforementioned attire, been able to wear one star in addition to the full-size decorations. With a dark suit it is not permitted to wear both a star and a neck badge.

Miniatures previously had to be acquired separately by the recipient, and prior to 1970 their use was restricted mainly to private occasions and to official events where the President of the Republic of Finland was not wearing the Grand Cross with Collar of the Order of the White Rose of Finland. However, since 1970 the wearing of miniatures has been permitted with a white tie (full evening dress) on all occasions at which decorations are worn. Since 1990, it has been possible to wear decorations at black tie (dinner jacket) events, but only miniatures are permitted. Ladies have been able since 1979 to wear miniatures on all occasions at which decorations are worn. Recipients of the Cross of Liberty have received miniatures from the Order since 2009. The Orders of the White Rose of Finland and the Lion of Finland have issued miniatures to Knights and above since 2015.

# TERMS AND DEFINITIONS

---

---

<b>NECK BADGE</b>	A decoration worn around the neck.
<b>ORDER OF PRECEDENCE</b>	A list of decorations in the order of precedence applicable when wearing insignia. The list was confirmed in 1958 by the Grand Master and has since been added to.
<b>COMMANDER</b>	A class of decorations worn around the neck; Commander First Class also includes a star worn on the chest.
<b>DIPLOMA</b>	Every decoration includes a diploma stating that the recipient is entitled to wear the decoration in question. The diploma gives the recipient's name and title.
<b>ROSETTE</b>	A round rosette in the colour of the Order's ribbon. A demi-barrette under the rosette indicates the class, from Grand Cross to Commander (see DESIGNATION).
<b>RIBBON BAR</b>	Decoration ribbon attached to a bar 10 mm high and worn on a military or other uniform.
<b>DESIGNATION</b>	A rosette, ribbon bow or 3 mm wide ribbon worn with civilian attire in place of full-size decorations and miniatures. Worn on the left lapel at events at which decorations are not used.
<b>MINIATURE</b>	A reduced size edition of the full-size decoration. In Finland, the size of miniatures is about 40 per cent of that of the full-size decorations.
<b>GRAND CROSS</b>	The highest class of decoration, worn on a sash running from the right shoulder to the left hip; a star is also included.
<b>MOTION</b>	The Chapter of the Orders may put forward a motion concerning the conferral of a decoration, without the need for a proposal (see PROPOSAL).
<b>PROPOSAL</b>	A proposal for conferring a decoration is submitted to the Chapter of the Orders by a member of the Government, the Chancellor of Justice, the Speaker of Parliament or the Chief of Defence.

- CHANCELLOR** Chairs the discussion in the Chapter of the Orders in the absence of the Grand Master, and presents to the Grand Master proposals and motions concerning the conferral of decorations.
- GRAND MASTER** Only the Grand Master has the right to confer decorations of the Orders. The President of the Republic of Finland is the Grand Master of the Orders of the White Rose of Finland and the Lion of Finland. The Grand Mastership of the Order of the Cross of Liberty is vested in the Commander-in-Chief of the Finnish Defence Forces, that is to say the President of the Republic of Finland.
- VICE CHANCELLOR** In the absence of the Chancellor, the Vice Chancellor chairs the discussion in the Chapter of the Orders and presents to the Grand Master proposals or motions concerning the conferral of decorations.
- SASH** The broad ribbon worn with a full-size Grand Cross. For gentlemen, the sash runs over the right shoulder to the left hip. It may, alternatively, be shortened and fastened with buttons to the waistcoat below the right shoulder, from where it runs down to the left hip. The sash is supplied in a standard length and must be adjusted according to the lower edge of the front of the tailcoat such that the bow is just below this lower edge. The sash is worn over the waistcoat when the President of the Republic of Finland is present, but is otherwise worn under the waistcoat. For ladies, the sash is narrower and is also worn from the right shoulder to the left hip.
- RECIPROCITY** In accordance with established international practice, decorations are conferred as a diplomatic courtesy on a reciprocal basis during state visits. The principle of reciprocity is also observed in the conferral of decorations to members of the diplomatic corps and defence attachés accredited to Helsinki when they vacate their position after having served in this capacity for a certain period. The principle of reciprocity requires that a Finn serving abroad in corresponding duties be awarded the same class of decoration by the country concerned.
- DARK SUIT** In Finland, when decorations are worn with a dark suit, they must be full-size decorations and the suit must be black, dark blue or dark grey. The shirt must be white and the tie a single, restrained colour (such as pearl grey).

# DECORATIONS OF THE ORDER OF THE WHITE ROSE OF FINLAND IN DIFFERENT LANGUAGES

---

---

Suomen Valkoisen Ruusun suurristi ketjuineen (SVR SR ketj.)  
Storkorset med kedja av Finlands Vita Ros' orden (FVR SK kedj.)  
Grand Cross with Collar of the Order of the White Rose of Finland (FWR GC collar)  
Kommandeur mit Grosskreuz und Kette des Ordens der Finnischen Weissen Rose  
Grand-Croix avec collier de l'Ordre de la Rose Blanche de Finlande

Suomen Valkoisen Ruusun suurristi (SVR SR)  
Storkorset av Finlands Vita Ros' orden (FVR SK)  
Grand Cross of the Order of the White Rose of Finland (FWR GC)  
Kommandeur mit Grosskreuz des Ordens der Finnischen Weissen Rose  
Grand-Croix de l'Ordre de la Rose Blanche de Finlande

Suomen Valkoisen Ruusun I luokan komentajamerkki (SVR K I)  
Kommendörstecknet av I klass av Finlands Vita Ros' orden (FVR K I)  
Commander First Class of the Order of the White Rose of Finland (FWR C I)  
Kommandeur I Klasse des Ordens der Finnischen Weissen Rose  
Croix de Commandeur de première classe de l'Ordre de la Rose Blanche de Finlande

Suomen Valkoisen Ruusun komentajamerkki (SVR K)  
Kommendörstecknet av Finlands Vita Ros' orden (FVR K)  
Commander of the Order of the White Rose of Finland (FWR C)  
Kommandeur des Ordens der Finnischen Weissen Rose  
Croix de Commandeur de l'Ordre de la Rose Blanche de Finlande

Suomen Valkoisen Ruusun I luokan ritarimerkki (SVR R I)  
Riddartecknet av I klass av Finlands Vita Ros' orden (FVR R I)  
Knight First Class of the Order of the White Rose of Finland (FWR K I)  
Ritter I Klasse des Ordens der Finnischen Weissen Rose  
Chevalier de première classe de l'Ordre de la Rose Blanche de Finlande

Suomen Valkoisen Ruusun ritarimerkki (SVR R)  
Riddartecknet av Finlands Vita Ros' orden (FVR R)  
Knight of the Order of the White Rose of Finland (FWR K)  
Ritter des Ordens der Finnischen Weissen Rose  
Chevalier de l'Ordre de la Rose Blanche de Finlande

Suomen Valkoisen Ruusun ansioristi (SVR Ar)  
Förtjänstkorset av Finlands Vita Ros' orden (FVR Fk)  
Cross of Merit of the Order of the White Rose of Finland (FWR Cm)  
Verdienstkreuz des Ordens der Finnischen Weissen Rose  
Croix du Mérite de l'Ordre de la Rose Blanche de Finlande

Suomen Valkoisen Ruusun I luokan mitali kultaristein (SVR M I kr)  
Medalj av I klass med guldkors av Finlands Vita Ros' orden (FVR M I gk)  
Medal First Class with Gold Cross of the Order of the White Rose of Finland (FWR M I gold)  
Medaille, I Klasse mit Goldkreuz des Ordens der Finnischen Weissen Rose  
Médaille de première classe, avec croix en or, de l'Ordre de la Rose Blanche de Finlande

Suomen Valkoisen Ruusun I luokan mitali (SVR M I)  
Medalj av I klass av Finlands Vita Ros' orden (FVR M I)  
Medal First Class of the Order of the White Rose of Finland (FWR M I)  
Medaille, I Klasse des Ordens der Finnischen Weissen Rose  
Médaille de première classe de l'Ordre de la Rose Blanche de Finlande

Suomen Valkoisen Ruusun mitali (SVR M)  
Medalj av Finlands Vita Ros' orden (FVR M)  
Medal of the Order of the White Rose of Finland (FWR M)  
Medaille des Ordens der Finnischen Weissen Rose  
Médaille de l'Ordre de la Rose Blanche de Finlande

*Oskar Pihl's drawing of the Medals of the Order of the White Rose of Finland.*



# DECORATIONS OF THE ORDER OF THE LION OF FINLAND IN DIFFERENT LANGUAGES

---

---

Suomen Leijonan suurristi (SL SR)  
Storkorset av Finlands Lejons orden (FLO SK)  
Grand Cross of the Order of the Lion of Finland (FL GC)  
Kommandeur mit Grosskreuz des Ordens des Finnischen Löwen  
Grand-Croix de l'Ordre du Lion de Finlande

Suomen Leijonan I luokan komentajamerkki (SL K I)  
Kommendörstecknet av I klass av Finlands Lejons orden (FLO K I)  
Commander First Class of the Order of the Lion of Finland (FL C I)  
Kommandeur I Klasse des Ordens des Finnischen Löwen  
Croix de Commandeur de première classe de l'Ordre du Lion de Finlande

Suomen Leijonan komentajamerkki (SL K)  
Kommendörstecknet av Finlands Lejons orden (FLO K)  
Commander of the Order of the Lion of Finland (FL C)  
Kommandeur des Ordens des Finnischen Löwen  
Croix de Commandeur de l'Ordre du Lion de Finlande

Suomen Leijonan Pro Finlandia -mitali (SL PF)  
Pro Finlandia-medaljen av Finlands Lejons orden (FLO PF)  
Pro Finlandia Medal of the Order of the Lion of Finland (FL PF)  
Pro Finlandia-Medaille des Ordens des Finnischen Löwen  
Médaille Pro Finlandia de l'Ordre du Lion de Finlande

Suomen Leijonan I luokan ritarimerkki (SL R I)  
Riddartecknet av I klass av Finlands Lejons orden (FLO R I)  
Knight First Class of the Order of the Lion of Finland (FL K I)  
Ritter I Klasse des Ordens des Finnischen Löwen  
Chevalier de première classe de l'Ordre du Lion de Finlande

Suomen Leijonan ritarimerkki (SL R)  
Riddartecknet av Finlands Lejons orden (FLO R)  
Knight of the Order of the Lion of Finland (FL K)  
Ritter des Ordens des Finnischen Löwen  
Chevalier de l'Ordre du Lion de Finlande

Suomen Leijonan ansioristi (SL Ar)  
Förtjänstkorset av Finlands Lejons orden (FLO Fk)  
Cross of Merit of the Order of the Lion of Finland (FL Cm)  
Verdienstkreuz des Ordens des Finnischen Löwen  
Croix du Mérite de l'Ordre du Lion de Finlande

*A Pro Finlandia Medal of the Order of the Lion of Finland in its case of issue.  
The case contains the full-size decoration, a miniature and a designation.  
In the order of precedence of decorations, the Pro Finlandia Medal is placed  
between the FWR Knight First Class and the FL Knight First Class.*





# CONTENTS

---

---

4	PREFACE
6	THE ORDERS OF THE WHITE ROSE OF FINLAND AND THE LION OF FINLAND: FACTS AND FIGURES
8	DECORATIONS OF THE ORDERS OF THE WHITE ROSE OF FINLAND AND THE LION OF FINLAND
8	Full-size decorations
9	Miniatures
9	Designations and ribbon bars
16	WEARING DECORATIONS WITH DIFFERENT FORMS OF ATTIRE
17	Wearing of full-size decorations
18	Wearing of miniatures
18	Special cases
20	WHITE TIE (FULL EVENING DRESS)
23	BLACK TIE (DINNER JACKET)
24	DARK SUIT
26	MILITARY AND OTHER UNIFORMS
28	SPECIAL CASES
29	DESIGNATIONS
30	ON THE HISTORY OF THE ORDERS
30	General history of the orders of knighthood
31	Orders of merit
32	Swedish and Russian Orders
33	The Order of the Cross of Liberty
35	The Orders of the White Rose of Finland and the Lion of Finland
40	Changing with the times
41	TERMS AND DEFINITIONS
43	DECORATIONS OF THE ORDER OF THE WHITE ROSE OF FINLAND IN DIFFERENT LANGUAGES
45	DECORATIONS OF THE ORDER OF THE LION OF FINLAND IN DIFFERENT LANGUAGES
47	CONTENTS
48	GUIDES TO THE ORDERS AND DECORATIONS OF FINLAND

# GUIDES TO THE ORDERS AND DECORATIONS OF FINLAND

---

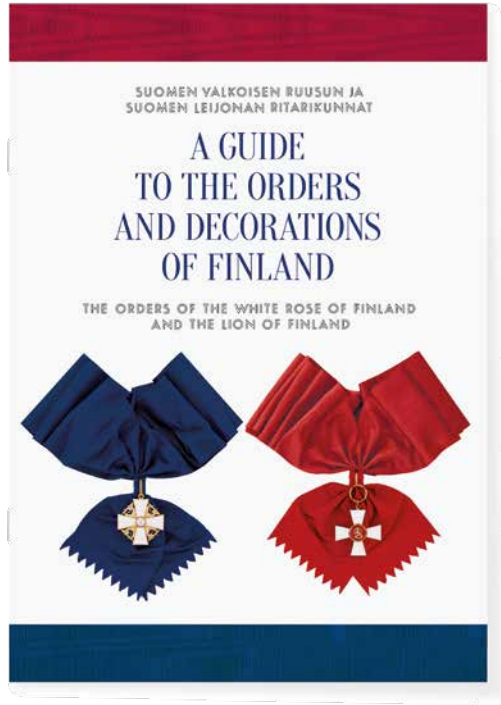

*(in Finnish and Swedish)*



*(in Finnish)*

[www.ritarikunnat.fi](http://www.ritarikunnat.fi)

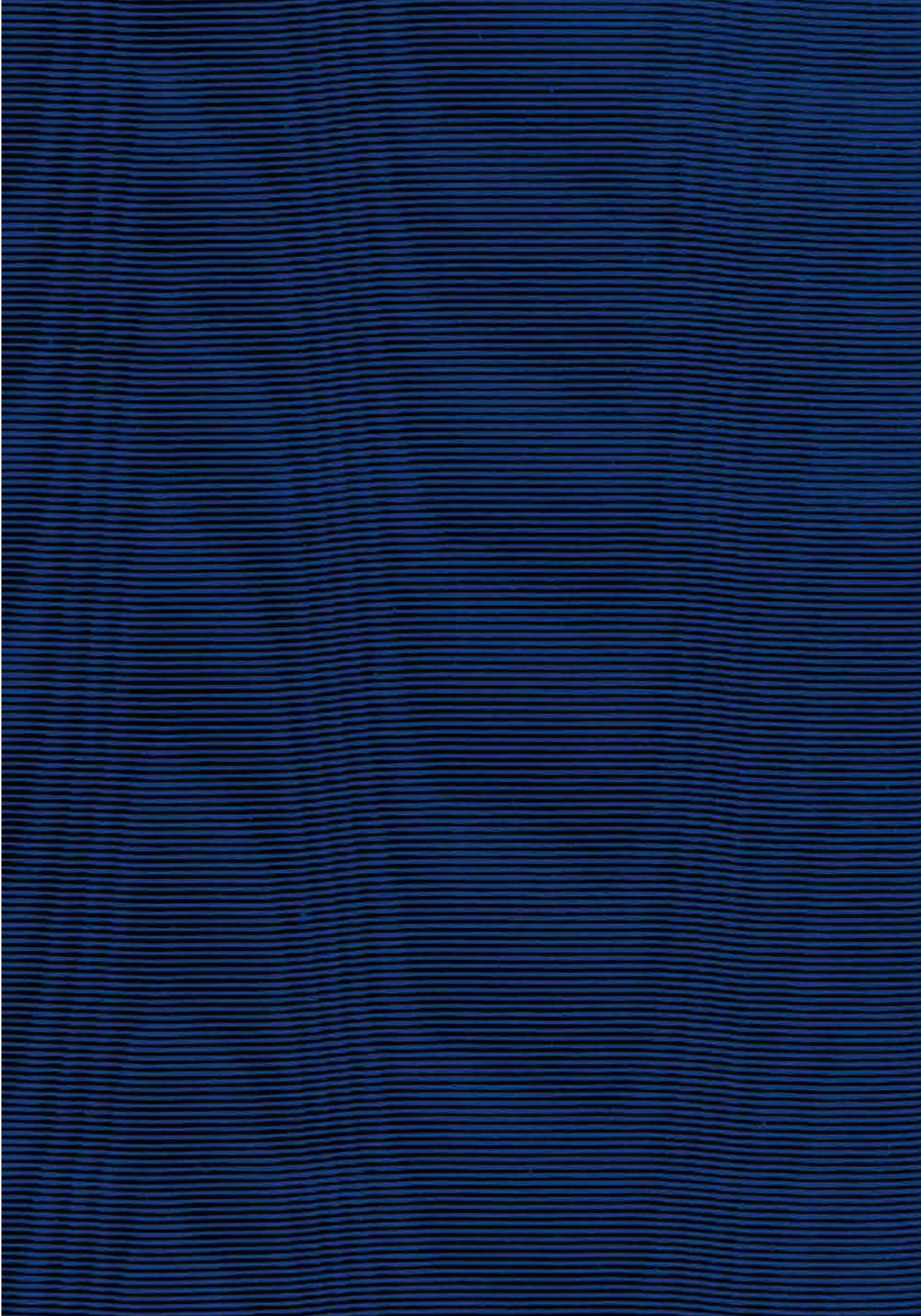



[www.ritarikunnat.fi](http://www.ritarikunnat.fi)